

Installation Instruction

STANDARD

5100 Series

Slide Track Door Closer

PULL SIDE

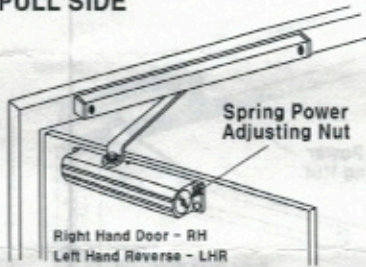

Right Hand Door - RH
Left Hand Reverse - LHR

SPRING POWER ADJUSTMENT

C.W. : CLOCKWISE
C.C.W. : COUNTER CLOCKWISE

DOOR CLOSER SIZE	CLOCKWISE TURNS OF ADJUSTING NUT	APPLICABLE DOOR LEAF WIDTH		APPLICABLE DOOR WEIGHT
		INTERIOR	EXTERIOR (SWING OUT)	
1	5 Turns C.C.W.	32" (0.81m)	28" (0.71m)	33-66 LBS (15-30kg)
2	3 Turns C.C.W.	36" (0.91m)	32" (0.81m)	66-99 LBS (30-45kg)
3	PRESET	42" (1.07m)	36" (0.91m)	99-143 LBS (45-65kg)
4	3 Turns C.W.	48" (1.22m)	42" (1.07m)	143-187 LBS (65-85kg)
5	6 Turns C.W.	54" (1.37m)	48" (1.22m)	187-264 LBS (85-120kg)
6	9 Turns C.W.	58" (1.47m)	54" (1.37m)	264-330 LBS (120-150kg)

PULL SIDE

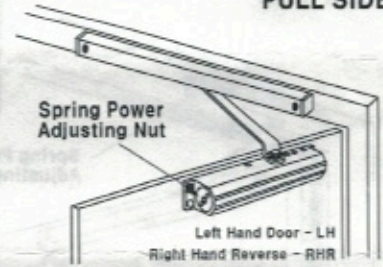

Left Hand Door - LH
Right Hand Reverse - RHR

★ INSTALLATION INSTRUCTIONS

- Use diagram to locate holes on door and frame:
4 on door for body.
2 on frame for track assembly.

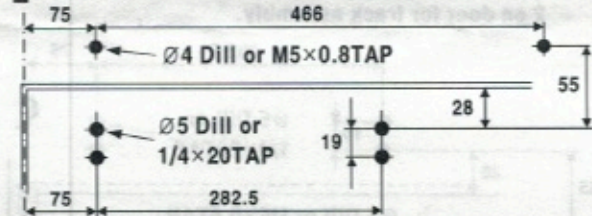

- Hold-Open: Slider, Stopper, Side cap in to the track.
Non Hold-Open: Slider, Side cap in to the track.

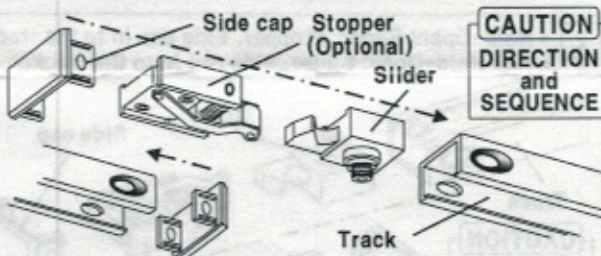

- Install the track assembly to the frame.
Install the body to the door.

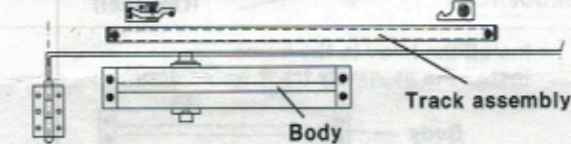

- Install main arm to pinion shaft, see Figure 1.
Set the main arm and the slider, see Figure 2.

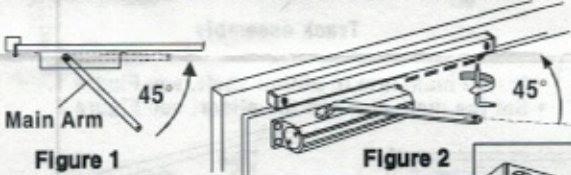

- Adjust Hold-Open angle and speed, power.
Install cover to the body

CLOSER ADJUSTMENT

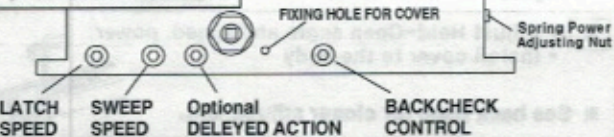

★ INSTALLATION INSTRUCTIONS

- Use diagram to locate holes on door and frame:
4 on door for body.
2 on frame for track assembly.

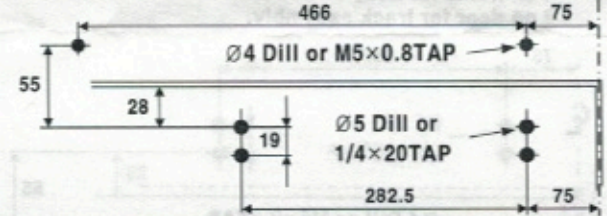

- Hold-Open: Slider, Stopper, Side cap in to the track.
Non Hold-Open: Slider, Side cap in to the track.

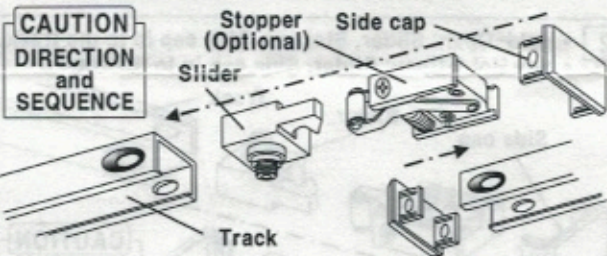

- Install the track assembly to the frame.
Install the body to the door.

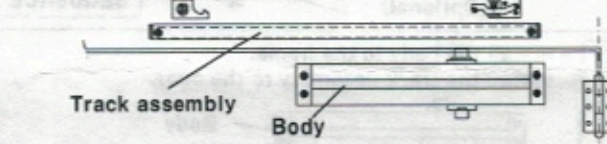

- Install main arm to pinion shaft, see Figure 1.
Set the main arm and the slider, see Figure 2.

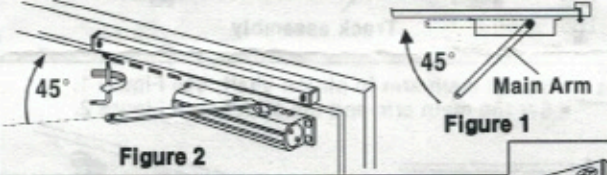

- Adjust Hold-Open angle and speed, power.
Install cover to the body

Closing cycle



Opening cycle

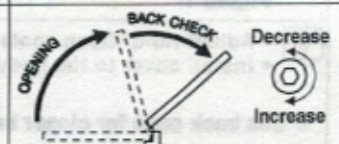

Installation Instruction

TOP JAMB

5100 Series

Slide Track Door Closer

PUSH SIDE

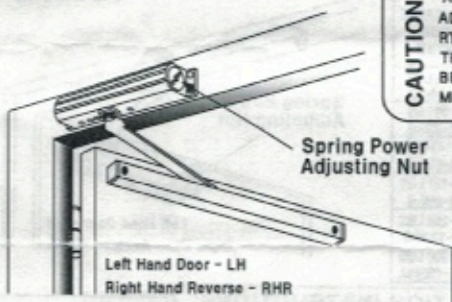

CAUTION

AN INCORRECTLY INSTALLED OR IMPROPERLY ADJUSTED DOOR CLOSER CAN CAUSE PROPERTY DAMAGE OR PERSONAL INJURY. THESE INSTALLATION INSTRUCTIONS SHOULD BE FOLLOWED TO AVOID THE POSSIBILITY OF MISAPPLICATION OR MISADJUSTMENT.

CAUTION

PUSH SIDE

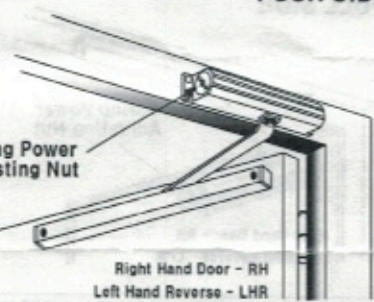

★ INSTALLATION INSTRUCTIONS

- 1 • Use diagram to locate holes on door and frame:
4 on frame for body
2 on door for track assembly.

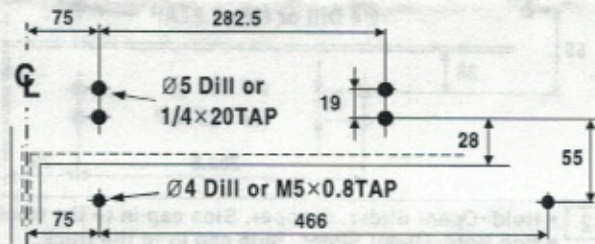

- 2 • Hold-Open: Slider, Stopper, Side cap in to the track.
• Non Hold-Open: Slider, Side cap in to the track.

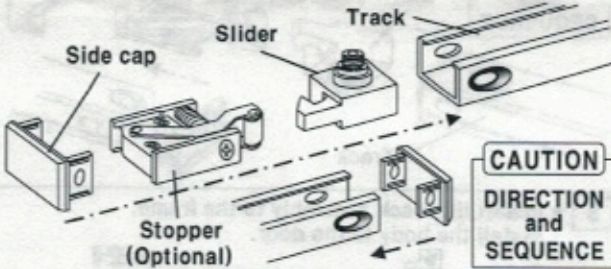

- 3 • Install the body to the frame.
Install the track assembly to the door.

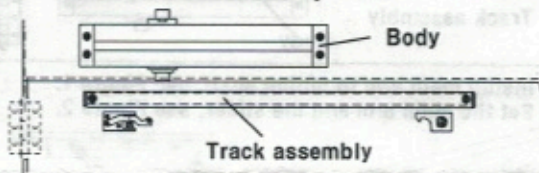

- 4 • Install main arm to pinion shaft, see Figure 1.
• Set the main arm and the slider, see Figure 2.

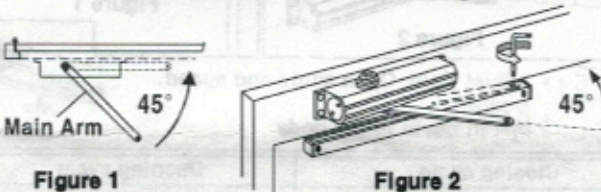

- 5 • Adjust Hold-Open angle and speed, power.
• Install cover to the body

* See back page for closer adjustment.



★ INSTALLATION INSTRUCTIONS

- 1 • Use diagram to locate holes on door and frame:
4 on frame for body
2 on door for track assembly.

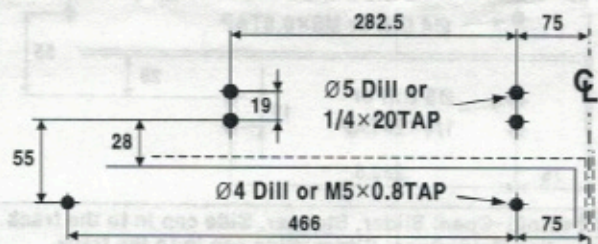

- 2 • Hold-Open: Slider, Stopper, Side cap in to the track.
• Non Hold-Open: Slider, Side cap in to the track.

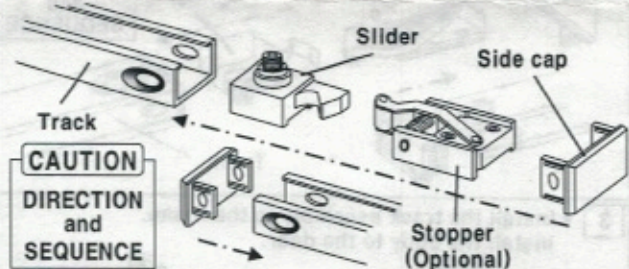

- 3 • Install the body to the frame.
Install the assembly track to the door.

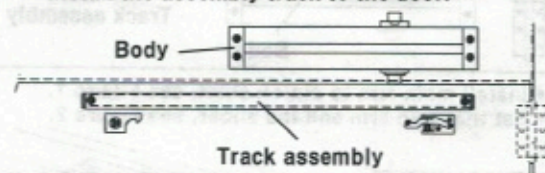

- 4 • Install main arm to pinion shaft, see Figure 1.
• Set the main arm and the slider, see Figure 2.

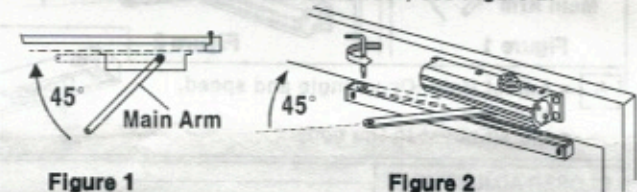

- 5 • Adjust Hold-Open angle and speed, power.
• Install cover to the body

* See back page for closer adjustment.

