



- PIN Access
- Mechanical Pushbutton Lock
- Single Access Code
- Cylindrical
- Lever

### Features

<b>Access Control:</b>	Mechanical pushbutton lock—eliminates problems and costs associated with issuing, controlling, and collecting keys and cards. Provides exterior access by combination, while allowing free egress.
<b>No Battery:</b>	Fully mechanical lock eliminates the material and labor expense of battery replacements
<b>Locking Device Options:</b>	Cylindrical latch with 3-hour UL/ULC fire rating on "A" labeled doors
<b>Number of Codes:</b>	Single access code—one easy to manage code for all users
<b>Programming:</b>	Lock is easily programmed via keypad without removing lock from the door
<b>Handing:</b>	Factory-handed; not field reversible
<b>Key Override (Optional):</b>	Small format interchangeable cores, large format removable cores
<b>Operation Modes:</b>	Single credential—access Passage (select models)—Allows access without using the lock entry code Feature activated from the inside with a thumbturn or key (included with all passage feature models) Privacy (select models)—Disables the lock from the inside so that the entry codes can not be used to gain access. Access is permitted using the key override only when in this mode.
<b>Economical:</b>	A cost effective access control solution

### Mechanical Features

<b>Construction:</b>	Heavy-duty cylindrical lock housing with cast front housing, unified trim plate, and fixed ADA-compliant levers
<b>Numeric Keypad:</b>	Vandal resistant, solid metal pushbuttons
<b>Handing:</b>	Factory-handed; not field reversible
<b>Standard Finishes:</b>	Satin Chrome 26D (626), Antique Brass 05 (609)
<b>Optional Finishes:</b>	Bright Brass 03 (605), Bright Chrome 026 (625)
<b>Backset:</b>	2 ¾" (70 mm), 2 ⅜" (60 mm)
<b>Latch:</b>	½" (13 mm) throw latch; ¾" (19 mm) throw latch (optional)
<b>Minimum Stile Recommended:</b>	5" (127 mm)
<b>Weight:</b>	8.25 lbs. (3.7 kg)
<b>Strike:</b>	Standard strike plate; ASA strike plate

### Key Override

<b>Interchangeable Cores:</b>	Small format–Best and equivalents (6 or 7-pin length)
<b>Removable Cores:</b>	Large format–Medeco/ASSA/Yale (5 or 6-pin length), Corbin Russwin, Schlage, and Sargent

### Installation

<b>Door Preparation:</b>	Easily installs on wood or metal doors. ASA 161 door preparation with additional through holes
<b>Door Thickness:</b>	1 3/8" (35 mm) to 2 1/4" (57 mm)–Pre-assembled to accommodate 1 5/8" (41 mm) to 2" (51 mm) doors
<b>Items Supplied Include:</b>	Lock assembly, installation manual, full-scale template, combination change plug and access key, and required installation hardware

### Certification and Testing

<b>Accessibility Standard:</b>	Americans with Disabilities Act (ADA)
<b>Durability:</b>	Compliance with D.O.D. 5220.22M; highly weather resistant
<b>Fire Rating:</b>	3-hour UL/ULC fire rating for "A" labeled doors

### Warranty

<b>Warranty:</b>	3-year warranty
------------------	-----------------

### Cylindrical

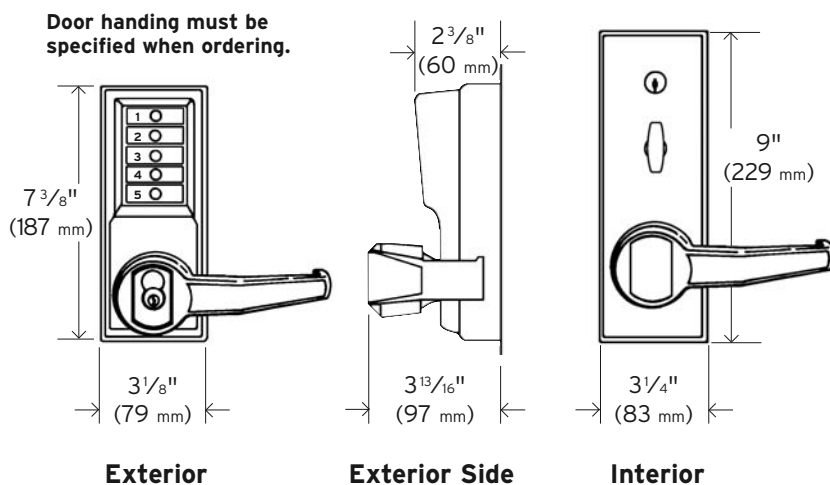

#### Model L1011

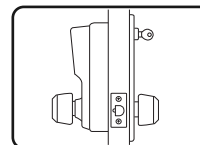

- Combination Entry
- Interior Combination Change

#### Model L1021

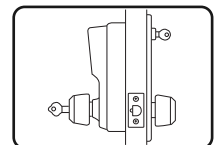

- Combination Entry
- Key Override (not supplied)
- Interior Combination Change

#### Model L1031

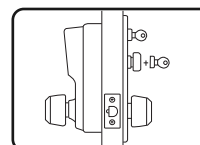

- Combination Entry
- Interior Combination Change
- Passage

#### Model L1041

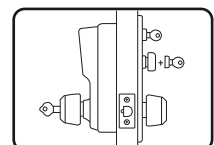

- Combination Entry
- Key Override (not supplied)
- Interior Combination Change
- Passage

#### Model L1076

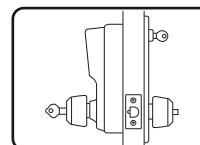

- Combination Entry
- Key Override (not supplied)
- Interior Combination Change
- Privacy (Lockout)

Please check model number to see what is included

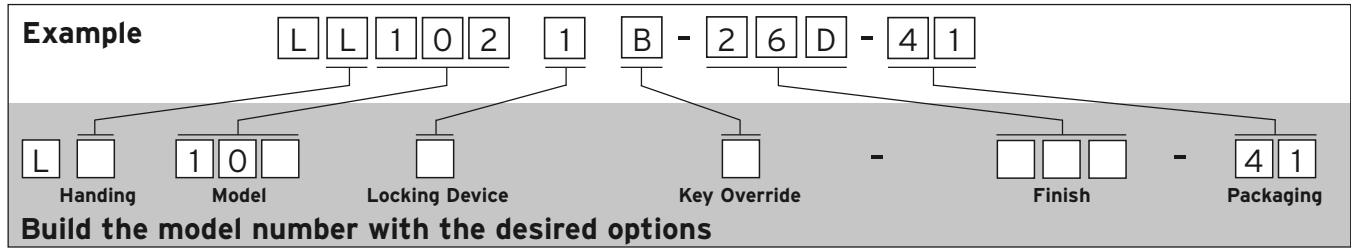

Base Model	Description
LL101126D41	Cylindrical Lock with Lever, No Key Override

Key Override Options+	Description
B	I/C Best and Equivalents (6 or 7-pin Length)
C	R/C Corbin Russwin
M**	R/C Medeco/ASSA/Yale (5 or 6-pin Length)
R	R/C Sargent
S	R/C Schlage

### Choose one option from each category

Handing Options	Description
L	Left Hand or Left Hand Reverse
R	Right Hand or Right Hand Reverse

Function Options	Description
1	Combination Entry Only
2	Combination Entry and Key Override
3	Combination Entry and Passage
4	Combination Entry, Key Override and Passage
7	Combination Entry, Key Override and Privacy (Lockout) (Requires "6" Locking Device Option)

Finish Options	Description
026	Bright Chrome (625)
03	Bright Brass (605)
05	Antique Brass (609)
26D	Satin Chrome (626)

Locking Device Options	Description
1	Cylindrical ½" (13 mm) throw latch, floating face plate, 2 ¾" (70 mm) backset (UL listed)
2	Cylindrical ½" (13 mm) throw latch, floating face plate, 2 ⅜" (60 mm) backset (UL listed)
5	Cylindrical ¾" (19 mm) throw latch, beveled face plate, 2 ¾" (70 mm) backset (UL listed)
6	Cylindrical ¾" (19 mm) throw latch, beveled face plate, 2 ¾" (70 mm) backset (UL listed)

### Notes

+ **Interchangeable/Removable core cylinders are not included with the lock**

\*\* **Medeco/ASSA/Yale (5 and 6-pin length)**  
5 and 6-pin Medeco/ASSA cylinders require a special knob spacer (Included in Package).

### Simplex® 2015 Series

Model	Description
54266	Blank Keys
54266-1-11	Master Keys for key override models. (Old #54266-1) (Specify Keycut)
54266-2-11	Service Keys for override models. (Old #54266-2) (Specify Keycut)

### Simplex® 6200 Series

Model	Description
55072-03-01	Filler Plate—Bright Brass
55072-26D-01	Filler Plate—Satin Chrome
55072-19-01	Filler Plate—Black

### Simplex® 900 Series

Model	Description
800-04-41	Adapter kit for doors with metal frames. Includes riser plates and surface mounted strike. Finish 04 Satin Brass; packaged 1 per box. (Old #74464/74468)
800-26D-41	Adapter kit for doors with metal frames. Includes riser plates and surface mounted strike. Finish 26D Satin Chrome; packaged 1 per box. (Old #74464/74468)
805-26D-41	Face plate shield. Not for use with key override models. Inhibits unauthorized observation of the combination. Finish 26D Satin Chrome; packaged 1 per box. (Old #24081-000-01)
54266	Blank Keys
54266-1-11	Master Keys for key override models. (Old #54266-1) (Specify Keycut)
54266-2-11	Service Keys for key override models (Old # 54266-2) (Specify Keycut)

### Simplex® 1000, L1000 & 5000 Cores & Wrap Plates

Model	Description
204231-03-41	Wrap Plate, 10 ½" (267 mm), Bright Brass (605)
204231-05-41	Wrap Plate, 10 ½" (267 mm), Antique Brass (609)
204231-26D-41	Wrap Plate, 10 ½" (267 mm), Satin Chrome (626)
204232-03-41	Wrap Plate, 15" (381 mm), Bright Brass (605)

204232-05-41	Wrap Plate, 15" (381 mm), Antique Brass (609)
204232-26D-41	Wrap Plate, 15" (381 mm), Satin Chrome (626)
20484-03-01	Best Equivalent SFIC Bright Brass (605)
201484-05-01	Best Equivalent SFIC Satin Brass (609)
201484-26D-01	Best Equivalent SFIC Satin Chrome (626)
201600-083-01	Anti-Spy Shield (1000/L1000 Models Only)
204022-000-01	Latch Extension Assembly converts to 3¾" (10 cm) Backset
204023-000-01	Latch Extension Assembly converts to 5" (13 cm) Backset
54644-000-41	Weather Cover (smoke colored)
64754-000-01	Lubriplate Aero Grease Tubes (1.75 oz tubes) 150°F to -70°F (66°C to -57°C)
64684-26D-01	Installation Jig (1000/L1000/5000/E5000)

### Simplex® Mounts\*

Model	Description
204246-000-41	<b>LD Series—450 &amp; 470</b> Dual Mount
04083-000-41	<b>8100</b> Series
204086-000-41	<b>EE1000</b> Series
204087-000-41	<b>LP1000</b> Series
203053-000-41	<b>900</b> Series— <b>904 &amp; 919</b> Dual Mount
204189-000-41	<b>7100</b> Series— <b>7108 &amp; 7104</b> Dual Mount
204092-000-41	<b>7100</b> Series—( <b>7106</b> Series Only)
204094-000-41	<b>6200</b> Series
204096-000-41	<b>2015</b> Series
203044-000-41	<b>1000, L1000, 5000</b> Series
74378-CH	<b>3000</b> Series Narrow Stile
SP5000 ACLMT	Simplex <b>5000</b> Acrylic Mount

\* Mounts do not include locks

Hardwood product demonstration mount, packaged 1 per box.